

# Compact Skimmerfilter™

## Operating Manual & Specifications

---

Read entire instructions prior to installing the unit.



# Operating Capacities

The SAViO Compact Skimmerfilter™ provides skimming action for ponds up to 300 sq. ft. The Compact Skimmerfilter™ comes with two biological filtration pads and has the built-in capacity for one integral Ultraviolet Clarifier (UV). UVs help create optimum water quality and are available for purchase separately.

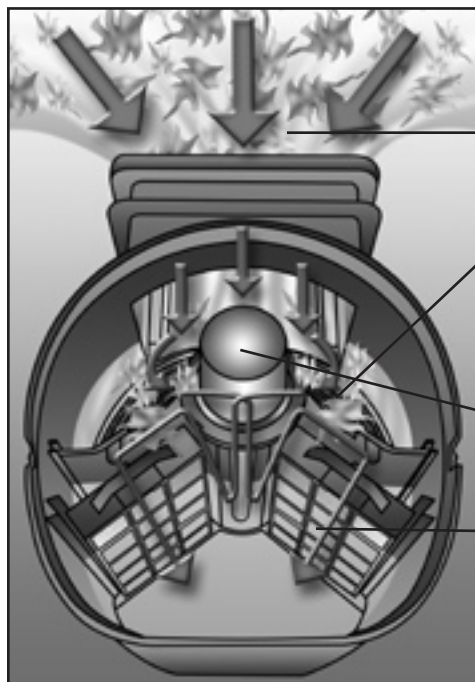

## **skimmer filtration**

removes up to 85% of debris before it sinks

## **macro filtration**

traps large debris and protects the pump

## **UV filtration** (optional)

eliminates green water

## **bio-filtration**

supports biological health, provides mechanical filtration and polishes water



## Important Safety Instructions



Locate a GFCI (ground fault current interrupter) protected power source nearby. Typically a 4 outlet, 15 amp, 110v, grounded, single phase service is sufficient. Refer to your electrical equipment specifications or consult a qualified electrician to determine power demands for your system.

## WARNINGS

- ✓ To prevent electrical shock disconnect all electrical devices including the UV Clarifier before servicing the Skimmerfilter.™
- ✓ Do not attempt to operate electrical devices with damaged cords or plugs.
- ✓ Do not attempt to remove any electrical device from the Skimmerfilter™ by pulling on its cord.
- ✓ Units with UV: UV light throws off radiation that can be harmful to skin and eyes. Always unplug all power to the Skimmerfilter™ prior to servicing the UV unit. Never look at or touch a UV bulb during operation.

# Components



# 1. Placement

A) Place the Compact Skimmerfilter™ opposite the waterfall or water return in an easily accessible location.

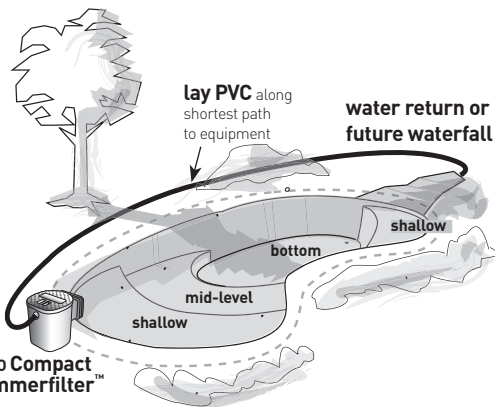

B) Avoid placing rocks or plants in front of the Compact Skimmerfilter™. Anything placed in front will interfere with the skimming action.

C) Waterfalls generally face the viewing area. Place the Compact Skimmerfilter™ so it faces the waterfall. This hides the Compact Skimmerfilter™ from view and allows for easy access.

D) Positioning the Compact Skimmerfilter™ on the downwind side of the pond will aid in the effective collection of floating debris. This is less important than placing the Compact Skimmerfilter™ opposite the waterfall but it is a significant design consideration.

# 2. Install Skimmerfilter™

## Mark Water Level



With the pond full, mark position of water level on the liner at the Skimmerfilter™ location. Partially drain pond 8"-10" inches before proceeding.

## Dig Skimmerfilter™ Hole

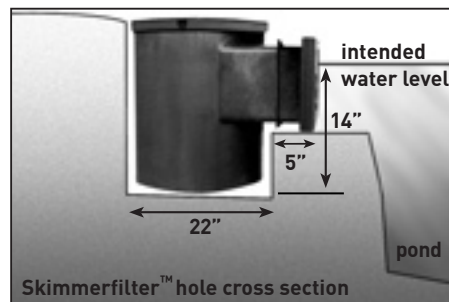

5" back from the coping shelf, dig a round hole measuring 22" across, with a depth of 14" below the marked water line. Dig the front of the hole 1/4" deeper than the back to compensate for settling.

## Dig Neck Channel (A)

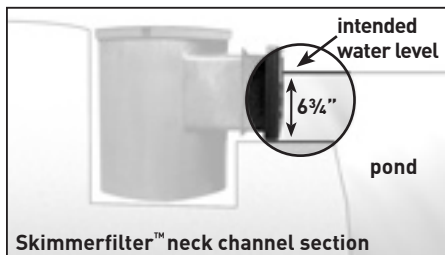

## Dig Neck Channel (B)

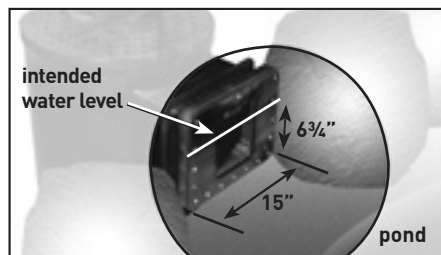

Dig a channel 6 3/4" below the water line [see diagram A], measuring 15" wide [see diagram B], to rest the neck of the Skimmerfilter™ Compact and level the bottom of excavation. **Do not dig too deeply or the soil may settle unevenly.**

# Install Skimmerfilter™ (continued)

## Insert Weir Dividers

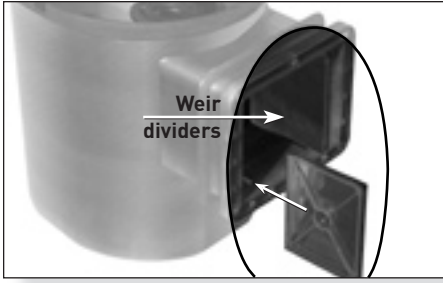

Insert weir dividers for 6" weir into two innermost tracks. 8.5" weir, use outermost tracks as shown in picture above.

## Insert Weir Door

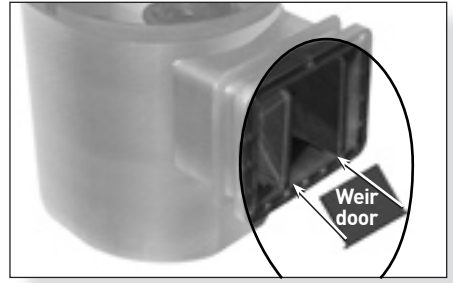

Using thumbs to hold tabs secure, push the weir door hinge tabs into the notches on the weir dividers. Lay the door horizontal in the Skimmerfilter™ neck.

## Place Skimmerfilter

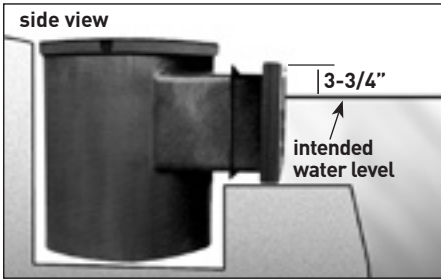

Place the Skimmerfilter™ in the hole. Check to make sure the intended water level meets the skimmer 3-1/4 inches below the top of the neck. Adjust up or down by adding or removing soil.

## Check Position

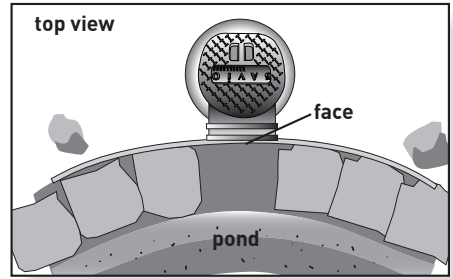

Verify that the face of the Skimmerfilter™ is flush with the back wall of the lined coping shelf. Adjust placement, if necessary.

## Verify Water Level

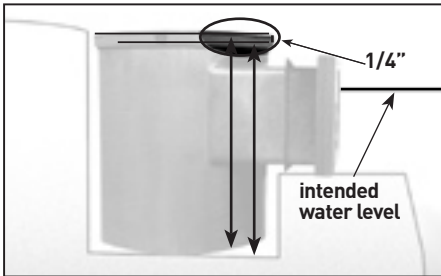

Level the unit front to back and side to side. Make the front edge 1/4" lower than the back edge. **Check water level once again.**

## Backfill

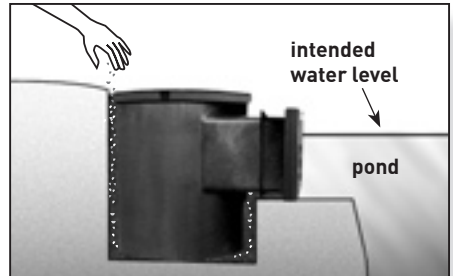

Place lid on top of Skimmerfilter™ and backfill around the entire unit. Use moist sand or pea gravel or, if unavailable, gravel and loose soil (free from clumps). Hand pack every two or three inches. Do not over compact. Lightly moisten the backfill to aid in settling.

## 3. Attach Liner

### Pull Liner Over Skimmerfilter™



Position pond liner over the Skimmerfilter™ mouth and hold it in place. Smooth liner free of wrinkles and folds. Wipe clean.

### Make Incision



Make a 3" wide incision through the centered liner 3/4" below the top of the Skimmerfilter™ opening.

### Attach Faceplate

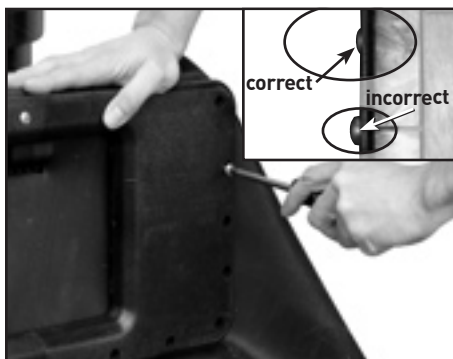

Use a #3 phillips head screwdriver to install screws into all four corners. Install the remaining screws. Tighten top, bottom and sides alternately until screw heads are flush to create a watertight seal. **Do not overtighten. Do not use a power drill.**

### Trim Liner



After the faceplate is secured down, use a knife to trim the liner inside the mouth of the Skimmerfilter™.

## 4. Install PVC

### Flex PVC

Reduces plumbing joints and the leaks that come with them it's easier to use, saves installation time and increases productivity. Flexible PVC is more freeze tolerant than rigid PVC, glues to standard PVC fittings and its black color makes easier to hide.

### Trench For PVC

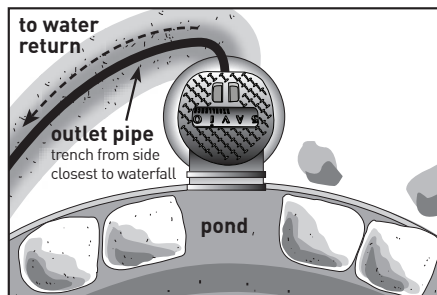

Dig a trench for the output pipe. Use the side closest to your water return or waterfall. Extend this trench so that it connects to the waterfall filter.

## 4. Install PVC (continued)

---

### Bury PVC



Bury the SAVio Aqua Flex PVC™ below frost line. Dig a trench (shovel width) 10" below existing ground level along the pond perimeter from the SAVio Skimmerfilter™ to the Livingponds Waterfall Filter™ or water return.

## 5. Connect Pump

---



### Submersible Pump

The Skimmerfilter™ tank protects and hides the submersible pump. The leaf basket protects the pump from large debris and reduces clogging. Use a solids handling pump designed for water gardening applications.



## 5. Connect Pump (continued)

### Cut grommet



Cut grommet to corresponding flex PVC size.

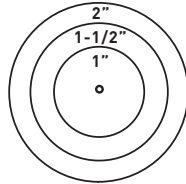

PVC Size	Diameter Hole
1"	1-1/2"
1-1/2"	2"
2"	2 1/2"

### Attach assembly



Attach assembly to pump prior to installation.

### Lower pump



Place the pump and plumbing assembly into the Skimmerfilter™.

### Attach PVC



Insert PVC through rubber grommet. Apply primer, then glue PVC to pump plumbing assembly.

## 6. Finishing Up

### Finish Coping



To hide the Skimmerfilter™ from view extend coping shelf rockwork up to both sides of the Skimmerfilter™ opening.

### Hide Neck



Place a flat rock over the Skimmerfilter™ neck to camouflage.

# Maintenance

---

Under normal operating conditions this Skimmerfilter™ will provide years of trouble-free use. Here are a few items which will require periodic maintenance:

- 1) Check and remove debris captured in the leaf basket every week or as needed. The frequency required will vary seasonally, with cleaning required more often in the fall than at other times.
- 2) Clean the filter mat cartridges when they appear dirty or before there is a noticeable decrease in the flow of water to the pump chamber. Use clean water from the pond. Avoid using chemicals or scrubbing the media. Do not allow filter mat to dry out during cleaning. Add beneficial bacteria and replace.

# Winterization

---

Prepare for winterization in mid-to-late November, or when ice persistently develops on the pond. Keep equipment winterized until late February or early March when the water temperature rises to 40° F or higher consistently.

**If the pond is to be shut down in winter:**

- 1) Disconnect UV Clarifiers and store indoors.
- 2) Disconnect submersible pump, clean and store in a dry place.
- 3) Drain any plumbing lines not buried below frost line (18"-24" in agricultural zones 4-6).
- 4) Use plumber's heat tape on pipes and shut off valves. Insulate the pump house and exterior pumps and valves.
- 5) Remove and thoroughly clean filter mat.

# Look for Other Innovative Products From SAVIO

---



## **SAVIO Pond Packages™**

*The best, most complete way to build a pond.  
Professional results that will last. Three sizes available.*



## **SAVIO Water Master Pumps™**

*High head pressure and affordable.  
Oil-less for fish safety*



# Troubleshooting

Faults	Possible Causes	Remedies
Pump chamber runs dry during operation.	Low water level in pond.  Weir door closed/stuck/obstructed.  Weir not large enough for pump flow.	Add water to pond. Water level should be between 3/4" above or below optimum water mark on faceplate.  Ensure free movement of weir door/ remove obstruction.  Reduce pump flow. Install smaller pump. Install larger weir assembly.
Water leak around faceplate.	Faceplate screws not tight.  Faceplate not sealed properly.	Use #3 phillips screwdriver to hand tighten screws snugly.  Remove weir face, clean liner of mud or gravel, smooth wrinkles. Reinstall.
Filter pad requires frequent cleaning.	Pump flow rate too high.  Heavy waste load in pond due to fish or plant debris.	Adjust pump flow rate to below recommended maximum.  Remove filter pad. Add a SAVIO Livingponds™ filter.
No skimming action.	Weir door closed/stuck/obstructed.  Pump is not functioning.	Ensure free movement of weir door/ remove obstruction.  Check operation of the pump and pump screen (if equipped).

## Replacement parts for Compact Skimmerfilter™

Code	Item	Code	Item
RC001	Screw Packet	RC010	Baffle Rear
RC002	Replacement Filter Mat	RC011	Baffle Top
RC003	Tank	RC012	8.5" Faceplate
RC004	Lid	RC013	6" Faceplate
RC005	Basket	RC014	8.5" Faceplate Seal
RC006	Baffle Front	RC015	6" Faceplate Seal
RC007	Filter Frame Front	RC016	Basket Handle
RC008	Filter Frame Rear	RC017	8.5" Weir Door
RC009	Weir Divider	RC018	6" Weir Door

# Customer Service Information



Savio Engineering, Inc.

8 Water Garden Way  
Santa Fe, NM 87508 USA

<http://www.savio.cc> • email: [support@savio.cc](mailto:support@savio.cc)

## Warranty (Send in the enclosed warranty card)

SAVIO Engineering, Inc. provides a manufacturer's limited warranty of 5 years from original purchase date. Warranty is non-transferable. Within the warranty period SAVIO will repair materials with manufacturing deficiencies at their discretion. This warranty does not cover any faults caused by improper use, installation and handling of the device or as a result of wear and tear. SAVIO Engineering, Inc. does not assume liability for consequential damage caused by the failure of the SAVIO Skimmerfilter.™ Warranty is void if the product is not used in accordance with instructions. For warranty claims, please contact your dealership.

## Innovative, precision engineered solutions Advanced water gardening products for healthy, clean living ponds.



Skimmerfilters™



Livingponds Filters™



Pond Packages



Ultraviolet Clarifiers



Water Master Pumps™



Automated Water  
Level Sensor™



Springflo Bio Filter  
Media™



Greenex® Micro Granules



Aqua Flex PVC™



Black Foam



Water Treatments